

Replacing the UV Bulb

Open the filter chamber following the instructions on page 2

Snip off the plastic retainer (for shipping only:
doesnot need to be replaced)

Pull the bulb upward out of the connector

Push the replacement bulb firmly into the connector

Close the filter chamber following instructions on page 3

Airpura limited warranty

5 years on parts and 10 years labor

Register on line at www.airpura.com

To close the filter chamber

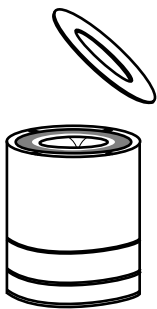

Replace the gasket

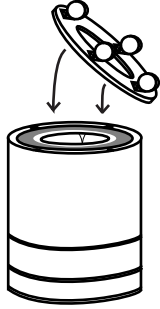

Position the indentation in the cover into the center of the HEPA filter

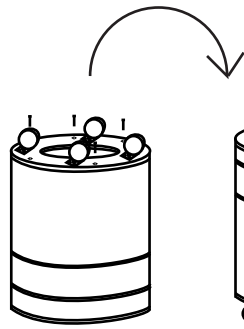

Replace the 4 screws and tighten

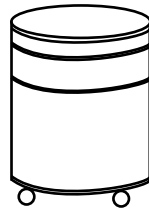

Turn the Airpura back onto it's casters

Airpura

AIR PURIFIERS

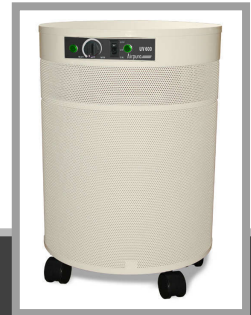

Operating & Filter Replacement Directions

UV600

Thank You for choosing an
Airpura High Efficiency Air Purifier
To bring you the benefits of clean indoor air

To Begin Using Your Airpura...

- Inspect the exterior of your Airpura to verify there is no damage from shipping. If any damage is noted please follow the instructions in the Airpura returns policy.
- Wipe the unit with a damp cloth to remove any dust from packaging
- Plug the unit into a regular grounded 110 volt outlet
- Turn on the unit to MAX and allow it to run for a few minutes
- Set the variable speed control to the level you wish
- The most efficient way to use your Airpura for regular air quality maintenance is to run it at a low speed 24 hours a day 7 days a week

Feel the difference breathing clean air makes
to your health

Filter Maintenance and Replacement

The Pre-Filter

- Can be vacuumed from the exterior of the unit once a month or more often.
- Should be replaced at least after 12 months of use

To vacuum the pre-filter

- Use the brush attachment on your vacuum cleaner
- Vacuum slowly around the mesh surface of the filter chamber

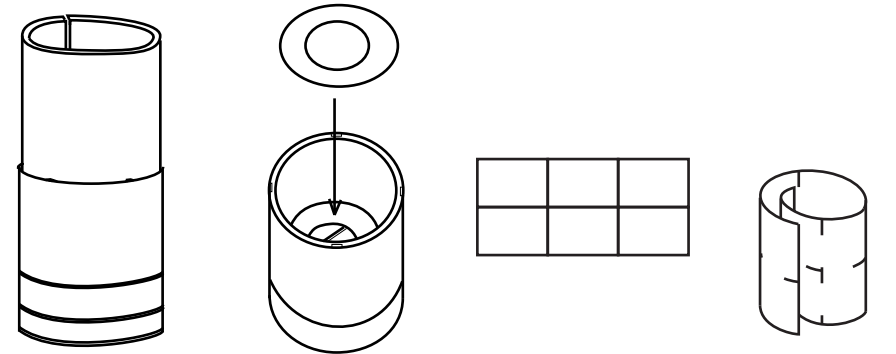
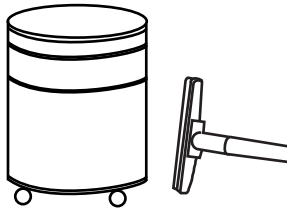

Position the pre-filter inside the filter chamber

Place a felt gasket at the bottom of the filter chamber

Unfold the filter slider (Supplied with replacement filters or on request Part#6F 001)

Roll it into a spiral

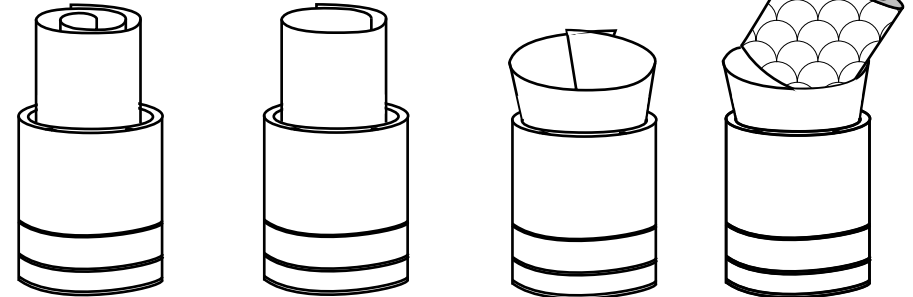

Insert the tube into the filter chamber inside the pre-filter

Let the spiral open to fill the opening

Open the top of the spiral to make a slight funnel

Insert the carbon canister into the funnel and hold it straight

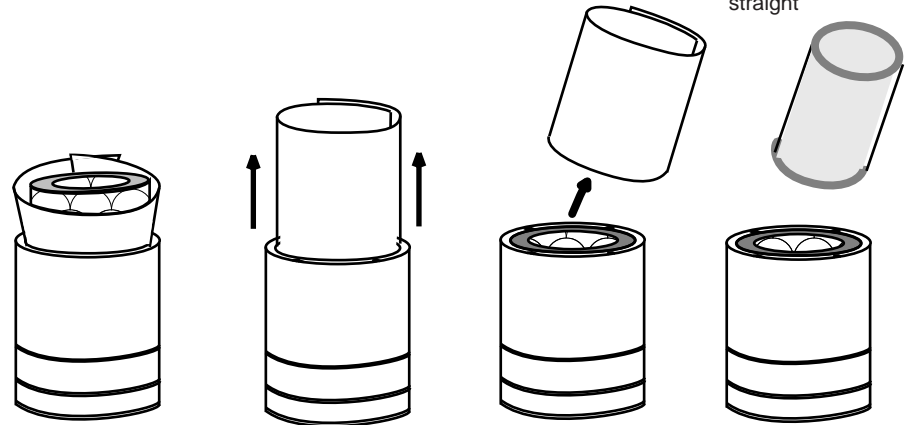

Let the canister slide down the filter slider

Pull the filter slider up out of the cavity using both hands and let the canister slide to the bottom of the cavity

Remove the filter slider and fold it for further use

Slide in the Hepa filter

See over for closing the filter chamber

The Activated Carbon Filter

- Should be changed as needed in heavy applications and at least every 24 months in normal use.

The HEPA Filter

- Should be replaced at least every 3 to 5 years of normal use

To open the filter chamber

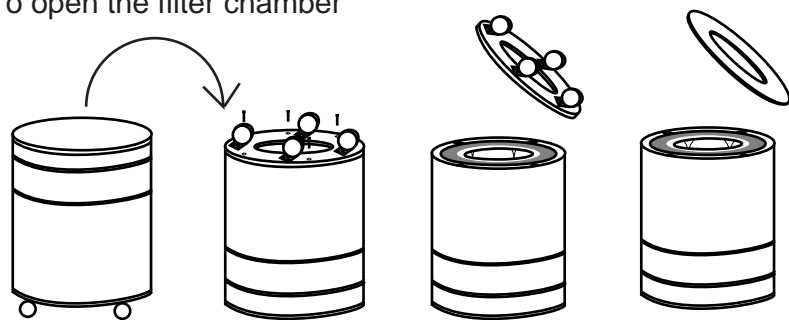

Turn over the Airpura

Remove the 4 retaining screws

Take off the cover

Remove the gasket